

SILCA NEWS

ALL THE NEW KEYS, AUTOMOTIVE SOLUTIONS, KEY CUTTING MACHINES, SOFTWARE UPDATES AND MUCH MORE

2024
FEBRUARY











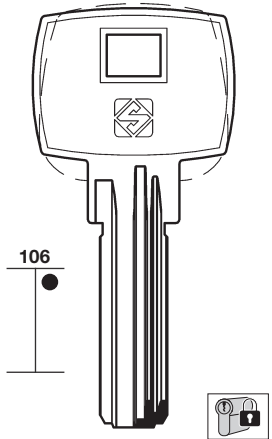

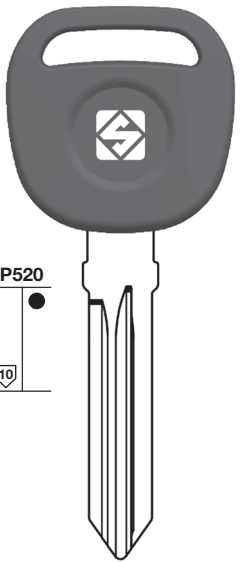

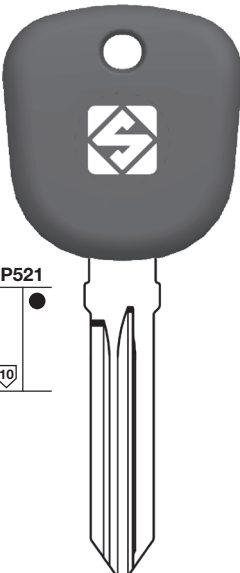
NR.
02

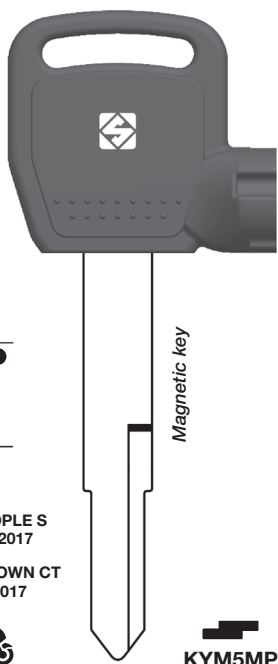

NETWORK WITH US

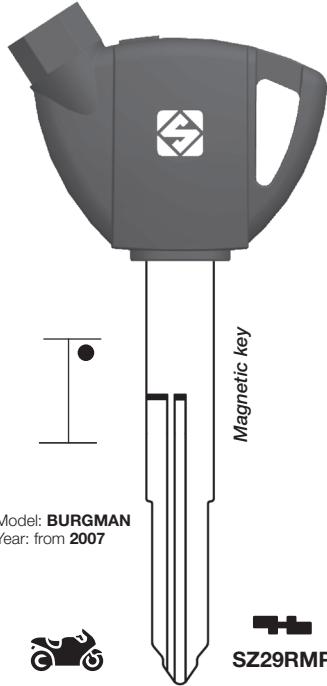

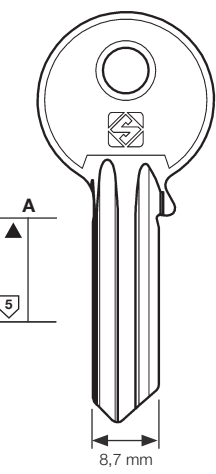
Silca key blanks are compatible with third party manufacturers' cylinders specified here below:

AL AHRAM*	GENERAL MOTORS*		
 <p>106</p>  <p>AHR4</p>  <p>8 052782 041711</p> <p>Box of 50</p>	 <p>P520</p>  <p>B111P</p>  <p>8 052782 041735</p> <p>Box of 25</p>	 <p>P521</p>  <p>B111TE</p>  <p>8 052782 042602</p> <p>Bag of 1</p>  <p>8 052782 042619</p> <p>Bag of 5</p>	<p>AL AHRAM* (EG)</p> <p>GENERAL MOTORS* (US)</p> <p>KYMCO* (KR)</p> <p>SUZUKI* (JP)</p> <p>UNIVERSAL*</p>
 <p>Magnetic key</p> <p>Model: PEOPLE S Year: 2012-2017</p> <p>Model: X-TOWN CT Year: from 2017</p>  <p>KYM5MP</p>  <p>8 052782 044200</p> <p>Box of 10</p>	 <p>Magnetic key</p> <p>Model: BURGMAN Year: from 2007</p>  <p>SZ29RMP</p>  <p>8 052782 044217</p> <p>Box of 10</p>	 <p>A</p> <p>5</p> <p>8,7 mm</p>  <p>UL066</p>  <p>8 052782 043746</p> <p>Box of 100</p>	<p>(*) This is a trademark of a third party not affiliated nor linked with Silca S.p.A. or the dormakaba Group. Silca S.p.A. and dormakaba Group do not own any intellectual property right nor have been granted any license with regard to such trademark, which is hereby used only to indicate the intended purpose of Silca's products.</p>

Silca key blanks are compatible with third party manufacturers' cylinders specified here below:

VACHETTE*		
 60 5 Shoulder milling view VAC2SM 8 052782 033013 Box of 50	 60 5 Shoulder milling view VAC48SM 8 052782 032924 Box of 50	 OV 5 Shoulder milling view VAC151SM 8 052782 032894 Box of 50
YALE*	ZEISS IKON*	
 1584 5 Shoulder milling view Orig. code: 1109 YA116SM 8 052782 043968 Box of 50	 OV 5 ZE9 8 003736 205178 Box of 100	 OV 5 ZE35 8 003736 206915 Box of 100

VACHETTE* (FR)

YALE* (GB)

ZEISS IKON* (DE)

(*) This is a trademark of a third party not affiliated nor linked with Silca S.p.A. or the dormakaba Group. Silca S.p.A. and dormakaba Group do not own any intellectual property right nor have been granted any license with regard to such trademark, which is hereby used only to indicate the intended purpose of Silca's products.



UPDATE YOUR SMART PRO NOW!

Data update with new vehicle applications / Aggiornamento dati con nuove applicazioni veicolo / Datenaktualisierung mit neuen Fahrzeug-Anwendungen / Mise à jour des données avec des nouvelles applications de véhicules / Actualización de datos con nuevas aplicaciones de vehículos / Atualização de dados com novas aplicações de veículos

Silca Advanced Diagnostics software to program car keys compatible with third party makes and models specified below:

REGION	MAKE*	MODEL*	YEAR START	YEAR END	KEY TYPE	SW MODULE
Europe	Opel-Vauxhall	Crossland	2020	2024	BLADE	ADS2188
Europe	Volkswagen	T-Roc	2018	2018	BLADE	ADS2292
Europe	Hyundai	Bayon	2021	2024	PROX	ADS2321
Asia	Abarth	695	2009	2019	BLADE	ADS2258
Asia	Subaru	Forester	2021	2023	PROX	ADS2330
New Zealand	Toyota	Yaris Cross	2020	2024	BLADE	ADS2296
USA	Toyota	Grand Highlander	2024	2024	PROX	ADS2328
USA	Toyota	Crown	2023	2023	PROX	ADS2328

(*) This is a trademark of a third party not affiliated nor linked with Silca S.p.A. or the dormakaba Group. Silca S.p.A. and dormakaba Group do not own any intellectual property right nor have been granted any license with regard to such trademark, which is hereby used only to indicate the intended purpose of Silca's products.

> More info at mykeyspro.com

Silca Proximity Car Key HU133RP17 compatible with Suzuki*

🇬🇧 New Proximity Key

Silca is pleased to introduce a new reference for duplicating proximity keys suitable for the Suzuki Swift; the perfect solution for replacing damaged or lost original keys, or to have a duplicate in case of emergency. The Silca Remote Car Key HU133RP17 has a similar design to the original key and is supplied ready-to-programme.

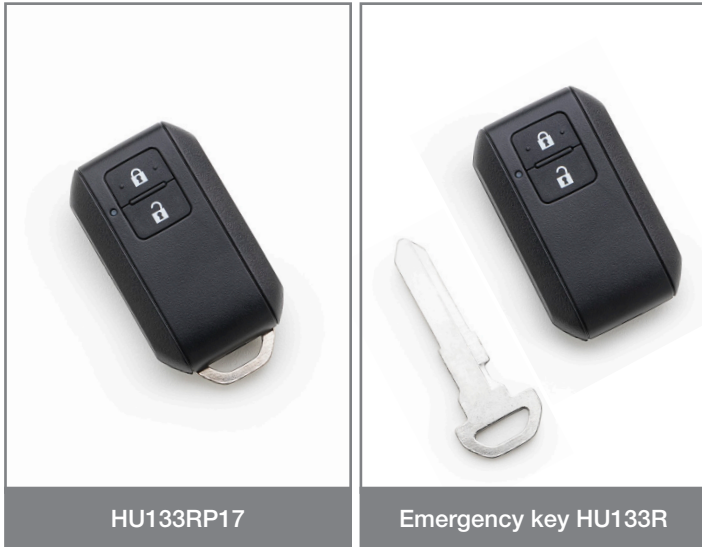

HU133RP17

Emergency key HU133R

CE The Silca Proximity Car Key HU133RP17 has been produced in conformity with CE mark European standards.



🇮🇹 Nuova Chiave di Prossimità

Silca presenta una nuova referenza per la duplicazione di radiocomandi di prossimità compatibile con la Suzuki Swift: la soluzione perfetta per sostituire chiavi originali danneggiate o perse, o semplicemente per avere un duplicato da utilizzare in caso di emergenza.

🇩🇪 Neuer Silca Keyless-Go-Schlüssel

Silca präsentiert eine neue Referenz zum Kopieren von Keyless-Go-Schlüsseln, die mit Suzuki kompatibel sind: die perfekte Lösung, um beschädigte oder verloren gegangene Schlüssel zu ersetzen oder einfach einen Zweitschlüssel zu haben, der im Notfall verwendet werden kann.

🇫🇷 Nouvelle Clé de Proximité

Silca présente un nouvel article pour reproduire des clés de proximité compatibles avec Suzuki: la solution parfaite pour remplacer les clés abîmées ou perdues, ou tout simplement pour avoir un duplicata à utiliser en cas d'urgence.

🇵🇹 Nova Chave de Proximidade Silca

A Silca apresenta uma nova referência para a duplicação de chaves de proximidade compatíveis com Suzuki: a solução perfeita para substituir chaves danificadas ou perdidas, ou simplesmente para ter um duplicado a utilizar em caso de emergência.

🇪🇸 Nueva Llave de Proximidad Silca

Silca presenta una nueva referencia para la duplicación de llaves de proximidad compatibles con Suzuki: la solución perfecta para sustituir llaves estropeadas, extraviadas o simplemente para obtener un duplicado requerido por el cliente.



Application list for HU133RP17

Make*	Model	Chassis	From	To	Buttons	Trp ID	Frequency	Silca profile
Suzuki	Swift	A2L (Z**3S)	2017	2021	2	49-1C	433 FM	HU133R

> More info at mykeyspro.com

* This is a trademark of a third party not affiliated nor linked with Silca S.p.A. or the dormakaba Group. Silca S.p.A. and dormakaba Group do not own any intellectual property right nor have been granted any license with regard to such trademark, which is hereby used only to indicate the intended purpose of Silca's products.

New Silca Remote Car Key NSN14R40 compatible with Nissan*

🇬🇧 New Remote Key

Silca is pleased to introduce a new reference for duplicating remote keys suitable for best selling Nissan models like the Qashqai and the Micra. The Silca Remote Car Key NSN14R40 has a similar design to the original key and is supplied ready-to-programme.



CE The Silca Remote Car Key NSN14R40 has been produced in conformity with CE mark European standards.



🇮🇹 Nuova Chiave Radiocomando

Silca presenta una nuova referencia per la duplicazione di chiavi radiocomando compatibile con modelli Nissan molto diffusi come la Qashqai e la Micra.

🇩🇪 Neuer Silca-Fernbedienungsschlüssel

Silca präsentiert eine neue Referenz die für das Kopieren von Fernbedienungsschlüsseln der beliebten Nissan-Modelle wie dem Qashqai und dem Micra kompatibel ist.

🇫🇷 Nouvelle Clé Télécommande

Silca présente un nouvel article pour reproduire des clés télécommande compatible avec les modèles Nissan populaires tels que le Qashqai et la Micra.

🇵🇹 Nova Chave Comando

A Silca apresenta uma nova referência para a duplicação de chaves comando compatíveis com modelos Nissan muito populares como o Qashqai e o Micra.

🇪🇸 Nueva Llave Mando

Silca presenta una nueva referencia para duplicar llaves mando compatible con modelos Nissan muy populares como el Qashqai y el Micra.



Application list for NSN14R40

Make*	Model	Chassis	From	To	Buttons	Trp ID	Frequency	Silca profile
Nissan	Micra	K14	2017	2022	2	49-1E	433 FM	NSN14
Nissan	Pulsar	C13	2014	2019	2	49-1E	433 FM	NSN14
Nissan	Qashqai	J11	2014	2017	2	49-1E	433 FM	NSN14
Nissan	X-Trail	T32	2014	2017	2	49-1E	433 FM	NSN14

> More info at mykeyspro.com

* This is a trademark of a third party not affiliated nor linked with Silca S.p.A. or the dormakaba Group. Silca S.p.A. and dormakaba Group do not own any intellectual property right nor have been granted any license with regard to such trademark, which is hereby used only to indicate the intended purpose of Silca's products.

Key Programming Software Update compatible with Toyota* ADS2328 - Code D756605AD

Programmes Toyota proximity keys via OBD even in an all keys lost situation



 The software programmes proximity keys for a wide selection of Toyota and Lexus models with password 39 and password 98 transponders. When used together with the new ADC2015 emulator, replacement keys can be programmed even in an all keys lost situation.

 **Consente di programmare le chiavi di prossimità Toyota e Lexus tramite l'OBD anche in assenza totale di chiavi**

Il software programma le chiavi di prossimità per una selezione di modelli Toyota con transponder password 39 e password 98.

 **Programmiert Keyless-Go-Schlüssel für Toyota und Lexus über das OBD, selbst in einer Situation, in der alle Schlüssel verloren gehen**

Die Software programmiert Keyless-Go-Schlüssel für eine Auswahl beliebiger Toyota*-Modelle mit Transpondern Passwort 39 und Passwort 98.

 **Programme les clés de proximité pour Toyota et Lexus via l'OBD même dans une situation où toutes les clés sont perdues**

Le logiciel programme des clés de proximité pour une sélection de modèles Toyota avec avec transpondeurs de password 39 et password 98.

 **Programa chaves de proximidade para Toyota e Lexus por meio do OBD, mesmo em uma situação de perda de todas as chaves**

O software programa chaves de proximidade para uma seleção de modelos Toyota com transponders senha 39 e senha 98.

 **Programa llaves de proximidad para Toyota y Lexus a través de OBD incluso en situaciones de pérdida de todas las llaves**

El software programa llaves de proximidad para una selección de modelos Toyota con contraseña de transpondedor 39 y contraseña 98.



What else is needed?



Emulator ADC2015
(if no working key
available)



Smart Pro













For Silca Proximity key
check MYKEYS Pro



> More info at mykeyspro.com

* This is a trademark of a third party not affiliated nor linked with Silca S.p.A. or the dormakaba Group. Silca S.p.A. and dormakaba Group do not own any intellectual property right nor have been granted any license with regard to such trademark, which is hereby used only to indicate the intended purpose of Silca's products.

Toyota* ADS2328 update - Software Applications (all regions)







TABLE										
 *	KEY TYPE									
Toyota Aurion 2009 - 2011	Proximity	✓	✓	✓	✓	ADC2000	✗	ADC2015	6E - 98	MYKEYS Pro
Toyota Camry Hybrid 2009 - 2011	Proximity	✓	✓	✓	✓	ADC2000	✗	ADC2015	6E - 98	MYKEYS Pro
Toyota Camry 2009 - 2011	Proximity	✓	✓	✓	✓	ADC2000	✗	ADC2015	6E - 98	MYKEYS Pro
Toyota Corolla 2009 - 2012	Proximity	✓	✓	✓	✓	ADC2000	✗	ADC2015	6E - 98	MYKEYS Pro
Toyota Fortuna 2015 - 2023	Proximity	✓	✓	✓	✓	ADC2000	✗	ADC2015	7A - 39	MYKEYS Pro
Toyota GT86 / 86 2012 - 2021	Proximity	✓	✓	✓	✓	ADC2000	✗	ADC2015	6E - 98	MYKEYS Pro
Toyota Hilux 2015 - 2023	Proximity	✓	✓	✓	✓	ADC2000	✗	ADC2015	7A - 39	MYKEYS Pro
Toyota Kluger 2010 - 2014	Proximity	✓	✓	✓	✓	ADC2000	✗	ADC2015	6E - 98	MYKEYS Pro
Toyota Landcruiser 2008 - 2015	Proximity	✓	✓	✓	✓	ADC2000	✗	ADC2015	6E - 98	MYKEYS Pro
Toyota Prado 2009 - 2017	Proximity	✓	✓	✓	✓	ADC2000	✗	ADC2015	6E - 98	MYKEYS Pro
Toyota Prius 2009 - 2015	Proximity	✓	✓	✓	✓	ADC2000	✗	ADC2015	6E - 98	MYKEYS Pro
Toyota Prius C 2012 - 2020	Proximity	✓	✓	✓	✓	ADC2000	✗	ADC2015	6E - 98	MYKEYS Pro
Toyota RAV4 2010 - 2012	Proximity	✓	✓	✓	✓	ADC2000	✗	ADC2015	6E - 98	MYKEYS Pro
Toyota Rukus 2010 - 2015	Proximity	✓	✓	✓	✓	ADC2000	✗	ADC2015	6E - 98	MYKEYS Pro
Toyota Tarago 2009 - 2019	Proximity	✓	✓	✓	✓	ADC2000	✗	ADC2015	6E - 98	MYKEYS Pro
Lexus CT200h 2011 - 2015	Proximity	✓	✓	✓	✓	ADC2000	✗	ADC2015	6E - 98	MYKEYS Pro
Lexus GS460 2008 - 2012	Proximity	✓	✓	✓	✓	ADC2000	✗	ADC2015	6E - 98	MYKEYS Pro
Lexus IS350 2010 - 2013	Proximity	✓	✓	✓	✓	ADC2000	✗	ADC2015	6E - 98	MYKEYS Pro
Lexus LS460 2009 - 2017	Proximity	✓	✓	✓	✓	ADC2000	✗	ADC2015	6E - 98	MYKEYS Pro
Lexus LS600h 2009 - 2017	Proximity	✓	✓	✓	✓	ADC2000	✗	ADC2015	6E - 98	MYKEYS Pro
Lexus LX570 2008 - 2015	Proximity	✓	✓	✓	✓	ADC2000	✗	ADC2015	6E - 98	MYKEYS Pro
Lexus RX450h 2009 - 2012	Proximity	✓	✓	✓	✓	ADC2000	✗	ADC2015	6E - 98	MYKEYS Pro
Lexus RX350 2009 - 2015	Proximity	✓	✓	✓	✓	ADC2000	✗	ADC2015	6E - 98	MYKEYS Pro
Lexus RX270 2012 - 2015	Proximity	✓	✓	✓	✓	ADC2000	✗	ADC2015	6E - 98	MYKEYS Pro

> More info at mykeyspro.com

* This is a trademark of a third party not affiliated nor linked with Silca S.p.A. or the dormakaba Group. Silca S.p.A. and dormakaba Group do not own any intellectual property right nor have been granted any license with regard to such trademark, which is hereby used only to indicate the intended purpose of Silca's products.



FUTURA PRO Software Vers. 3.45.0 DB 12.00 - Silca App. Vers. 3.0

NEW SYSTEMS						
LOCK MANUFACTURER*	LOCK SYSTEMS*	PROFILE	SERIES	SN	DATA CARD	CLAMP
ABUS*	CSI-KB68 (2T-6W)	-	-	2465	5367	01R-01J-02J
APECS*	Apecs AP	-	-	2470	5492	01R-01J-02J
AVOCET*	ABS Pioneer	A00001-C14888	10025	5490	01V
DOM* 	DOM RS 7SI (Prof. 302) (6+5)	-	-	2473	5447	01R-166-167
DOM* 	DOM RS 7SI (Prof. 302) (6P)	1234567	10021	5443	11V
DOM* 	DOM RS 7SI (Prof. 303) (6+5)	-	-	2474	5448	01R-166-167
DOM* 	DOM RS 7SI (Prof. 303) (6P)	1234567	10022	5444	11V
DOM* 	DOM RS SIRIUS (Prof. 300-301) (6+5)	-	-	2472	5442	01R-166-167
DOM* 	DOM RS SIRIUS (Prof. 300-301) (6P)	1234567	10020	5438	11V
dormakaba* GEGE*	PX-PXP (6P)	1234567890	10027	3706	01V
DORSET*	DORSET COMPUTER KEY	-	-	2464	5435	01R-01J-02J
FF-FACCHINETTI* 	Facchinetti C19	315700000024I-39FJ6J6J6J6J6	2475	5503	01R-01J-02J
KELOP*	K100	123456	10026	5500	01V
MLS MAUER* 	CY100 KT179 (6p)	000001-101092	2462	1851	01R-01J-02J
MLS MAUER* 	MLS Elite 1 KT179 (6p) - Red line	000001-101092	2461	1851	01R-01J-02J
MOIA*	MCHGYPC/C/30+10	-	-	2463	5495	01R-01J-02J

(*) This is a trademark of a third party not affiliated nor linked with Silca S.p.A. or the dormakaba Group. Silca S.p.A. and dormakaba Group do not own any intellectual property right nor have been granted any license with regard to such trademark, which is hereby used only to indicate the intended purpose of Silca's products.

> More info on **all Silca websites**



FUTURA PRO Software Vers. 3.45.0 DB 12.00 - Silca App. Vers. 3.0

NEW SYSTEMS

LOCK MANUFACTURER*	LOCK SYSTEMS*	PROFILE	SERIES	SN	DATA CARD	CLAMP
PROMOTER*	Promoter	12345	10023	5487	01V
SARGENT*	DG2-DG3 (6P)	123456	10024	428	08V
SPARK*	VIDA LH	5001-6174	9982	5393	01V
SPARK*	VIDA LH	7001-8174	9983	5393	01V
TOK-WINKHAUS*	Winkhaus OVSX (P6)	0123456789A	10007	5430	10V
TOK-WINKHAUS*	Winkhaus OVSX (VS-Position 1-3)	-	-	2426	5428	01R-148-51J
TOK-WINKHAUS*	Winkhaus OVSX (VS-Position 8)	-	-	2427	5429	01R-149-51J

(*) This is a trademark of a third party not affiliated nor linked with Silca S.p.A. or the dormakaba Group. Silca S.p.A. and dormakaba Group do not own any intellectual property right nor have been granted any license with regard to such trademark, which is hereby used only to indicate the intended purpose of Silca's products.

> More info on [all Silca websites](#)

Silca key blanks are compatible with third party manufacturers' cylinders specified here below:

TOK-WINKHAUS* (DE)

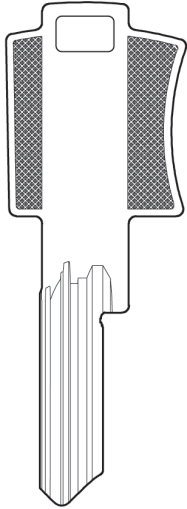

(OVSX System)

System protected by a password issued by Silca on receipt of authorization.

Sistema protetto da password rilasciata da Silca a fronte di autorizzazione.

System geschützt durch von Silca geliefertes Passwort auf Genehmigung.

Système protégé par un password qui est émis par Silca sur autorisation.

Sistema protegido con contraseña que manda Silca previa autorización.

Sistema protegido por uma password emitida por Silca contra a autorização.

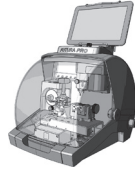

FUTURA PRO
≥ SW 3.45.0

OPTIONAL

• CODE

◊ COPY

D7A7234ZB

148 Jaw
Ganascia 148
148 Backe
Mâchoire 148
Quijada 148
Garra 148

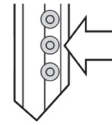

OPTIONAL

• CODE

◊ COPY

D744634ZB

51J Jaw
Ganascia 51J
51J Backe
Mâchoire 51J
Quijada 51J
Garra 51J

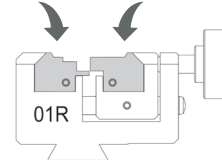
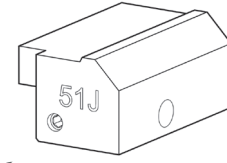
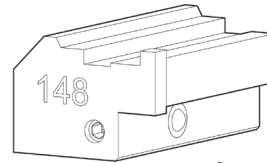

for cutting positions 1-3
pour les positions de coupe 1-3

per taglio posizioni 1-3
para posiciones de corte 1-3

für die Schnittpositionen 1-3
para as posições de corte 1-3

OPTIONAL

• CODE

◊ COPY

D7A7235ZB

149 Jaw
Ganascia 149
149 Backe
Mâchoire 149
Quijada 149
Garra 149

OPTIONAL

• CODE

◊ COPY

D744634ZB

51J Jaw
Ganascia 51J
51J Backe
Mâchoire 51J
Quijada 51J
Garra 51J

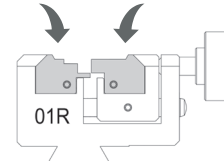
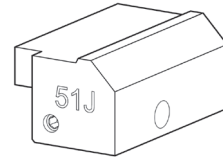
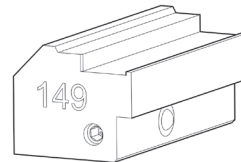

for cutting position 8
pour la position de coupe 8

per taglio posizione 8
para la posición de corte 8

für Schneidposition 8
para posição de corte 8

OPTIONAL

02D

D743673ZB

Cutter 02D
Fresa 02D
Fräser 02D
Fraise 02D
Fresa 02D
Fresa 02D



(*) This is a trademark of a third party not affiliated nor linked with Silca S.p.A. or the dormakaba Group. Silca S.p.A. and dormakaba Group do not own any intellectual property right nor have been granted any license with regard to such trademark, which is hereby used only to indicate the intended purpose of Silca's products.

Silca key blanks are compatible with third party manufacturers' cylinders specified here below:

TOK-WINKHAUS* (DE)

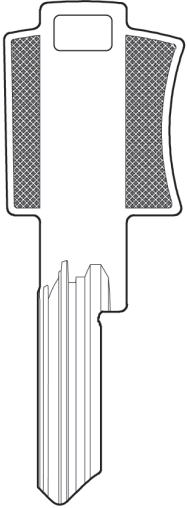

(OVSX System)

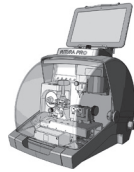

FUTURA PRO
≥ SW 3.45.0

OPTIONAL



NEW

D7A7256ZB

Clamp 10V
Morsetto 10V
10V Spannbacke
Etau 10V
Mordaza 10V
Mordente 10V

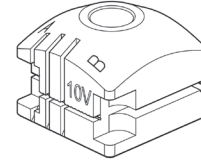

System protected by a password issued by Silca on receipt of authorization.

Sistema protetto da password rilasciata da Silca a fronte di autorizzazione.

System geschützt durch von Silca geliefertes Passwort auf Genehmigung.

Système protégé par un password qui est émis par Silca sur autorisation.

Sistema protegido con contraseña que manda Silca previa autorización.

Sistema protegido por uma password emitida por Silca contra a autorização.

(*) This is a trademark of a third party not affiliated nor linked with Silca S.p.A. or the dormakaba Group. Silca S.p.A. and dormakaba Group do not own any intellectual property right nor have been granted any license with regard to such trademark, which is hereby used only to indicate the intended purpose of Silca's products.

Silca key blanks are compatible with third party manufacturers' cylinders specified here below:

TOK-WINKHAUS* (DE)

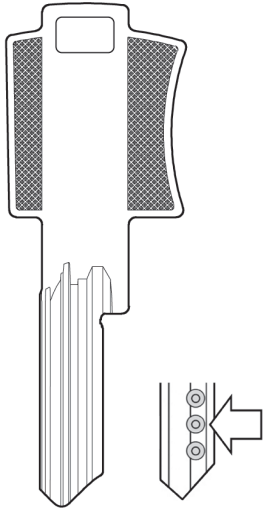

(OVSX System)

System protected by a password issued by Silca on receipt of authorization.

Sistema protetto da password rilasciata da Silca a fronte di autorizzazione.

System geschützt durch von Silca geliefertes Password auf Genehmigung.

Système protégé par un password qui est émis par Silca sur autorisation.

Sistema protegido con contraseña que manda Silca previa autorización.

Sistema protegido por uma password emitida por Silca contra a autorização.



TRIAX PRO
≥ SW 3.0.036 DB 59.06

OPTIONAL D7A7234ZB



148 Jaw
Ganascia 148
148 Backe
Mâchoire 148
Quijada 148
Garra 148

OPTIONAL D744634ZB



51J Jaw
Ganascia 51J
51J Backe
Mâchoire 51J
Quijada 51J
Garra 51J

NEW

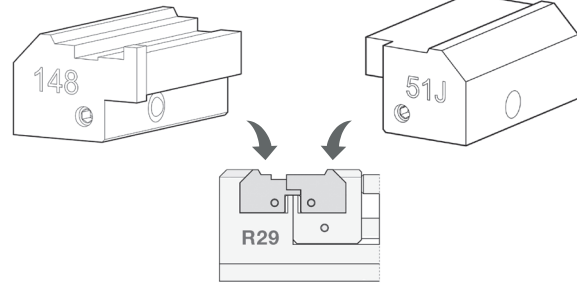

for cutting positions 1-3
pour les positions de coupe 1-3

per taglio posizioni 1-3
para posiciones de corte 1-3

für die Schnittpositionen 1-3
para as posições de corte 1-3

OPTIONAL D7A7235ZB



149 Jaw
Ganascia 149
149 Backe
Mâchoire 149
Quijada 149
Garra 149

OPTIONAL D744634ZB



51J Jaw
Ganascia 51J
51J Backe
Mâchoire 51J
Quijada 51J
Garra 51J

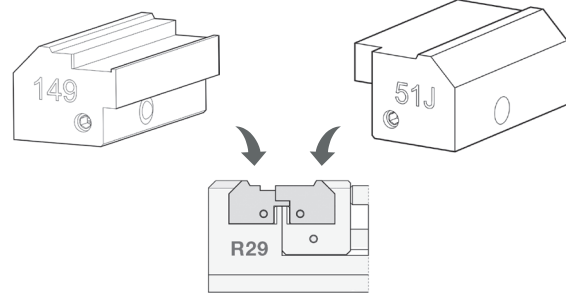

for cutting position 8
pour la position de coupe 8

per taglio posizione 8
para la posición de corte 8

für Schneidposition 8
para posição de corte 8

OPTIONAL



D7A3441ZB

Cutter W339 (carbide)
Fresa W339 (metal duro)
Fräser W339 (Hartmetall)
Fraise W339 (au carbure)
Fresa W339 (metal duro)
Fresa W339 (metal duro)

(*) This is a trademark of a third party not affiliated nor linked with Silca S.p.A. or the dormakaba Group. Silca S.p.A. and dormakaba Group do not own any intellectual property right nor have been granted any license with regard to such trademark, which is hereby used only to indicate the intended purpose of Silca's products.

Silca key blanks are compatible with third party manufacturers' cylinders specified here below:

TOK-WINKHAUS* (DE)

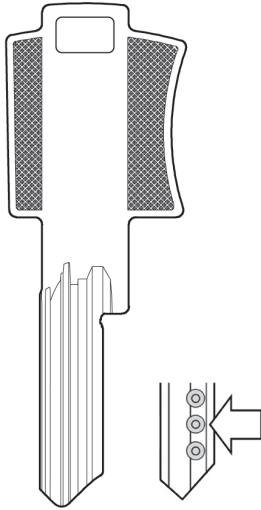

(OVSX System)

System protected by a password issued by Silca on receipt of authorization.

Sistema protetto da password rilasciata da Silca a fronte di autorizzazione.

System geschützt durch von Silca geliefertes Passwort auf Genehmigung.

Système protégé par un password qui est émis par Silca sur autorisation.

Sistema protegido con contraseña que manda Silca previa autorización.

Sistema protegido por uma password emitida por Silca contra a autorização.



TRIAX QUATTRO
≥ SW 1.4.072 DB 59.06

OPTIONAL D7A7234ZB



148 Jaw
Ganascia 148
148 Backe
Mâchoire 148
Quijada 148
Garra 148

OPTIONAL D744634ZB



51J Jaw
Ganascia 51J
51J Backe
Mâchoire 51J
Quijada 51J
Garra 51J

NEW

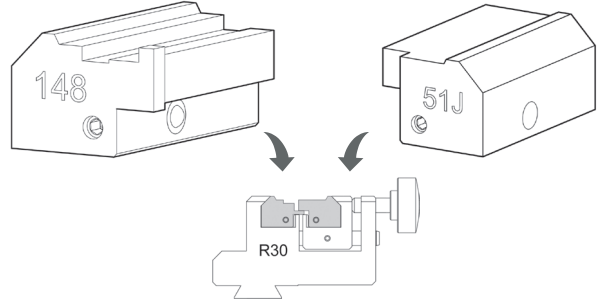

for cutting positions 1-3
pour les positions de coupe 1-3

per taglio posizioni 1-3
para posiciones de corte 1-3

für die Schnittpositionen 1-3
para as posições de corte 1-3

OPTIONAL D7A7235ZB



149 Jaw
Ganascia 149
149 Backe
Mâchoire 149
Quijada 149
Garra 149

OPTIONAL D744634ZB



51J Jaw
Ganascia 51J
51J Backe
Mâchoire 51J
Quijada 51J
Garra 51J

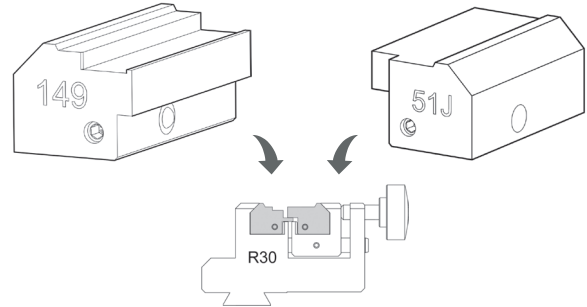

for cutting position 8
pour la position de coupe 8

per taglio posizione 8
para la posición de corte 8

für Schneidposition 8
para posição de corte 8

OPTIONAL



D7A3441ZB

Cutter W339 (carbide)
Fresa W339 (metal duro)
Fräser W339 (Hartmetall)
Fraise W339 (au carbure)
Fresa W339 (metal duro)
Fresa W339 (metal duro)

(*) This is a trademark of a third party not affiliated nor linked with Silca S.p.A. or the dormakaba Group. Silca S.p.A. and dormakaba Group do not own any intellectual property right nor have been granted any license with regard to such trademark, which is hereby used only to indicate the intended purpose of Silca's products.

Silca key blanks are compatible with third party manufacturers' cylinders specified here below:

TOK-WINKHAUS* (DE)

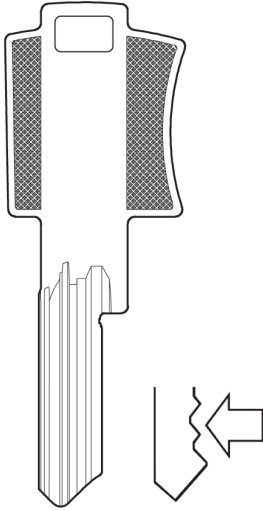

(OVSX System)

System protected by a password issued by Silca on receipt of authorization.
 Sistema protetto da password rilasciata da Silca a fronte di autorizzazione.
 System geschützt durch von Silca geliefertes Password auf Genehmigung.
 Système protégé par un password qui est émis par Silca sur autorisation.
 Sistema protegido con contraseña que manda Silca previa autorización.
 Sistema protegido por uma password emitida por Silca contra a autorização.



UNOCODE F800
UNOCODE F900

OPTIONAL



D7A7261ZB

Jaw set U28-L28
 Set ganasce U28-L28
 Satz Backen U28-L28
 Ens.mâchoires U28-L28
 Juego quijadas U28-L28
 Conjunto de garras U28-L28

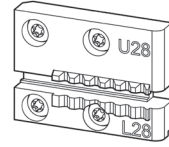

NEW



UNOCODE F100
UNOCODE F400
UNOCODE F600

OPTIONAL



D7A7261ZB

Jaw set U28-L28
 Set ganasce U28-L28
 Satz Backen U28-L28
 Ens.mâchoires U28-L28
 Juego quijadas U28-L28
 Conjunto de garras U28-L28

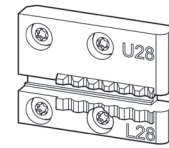

NEW



OPTIONAL



D7A3836ZB

V3 clamp
 Morsetto V3
 V3 Spannbacke
 Étau V3
 Mordaza V3
 Mordente V3

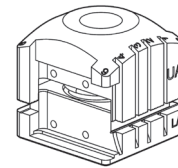

(*) This is a trademark of a third party not affiliated nor linked with Silca S.p.A. or the dormakaba Group. Silca S.p.A. and dormakaba Group do not own any intellectual property right nor have been granted any license with regard to such trademark, which is hereby used only to indicate the intended purpose of Silca's products.

Silca key blanks are compatible with third party manufacturers' cylinders specified here below:

DOM* (DE)

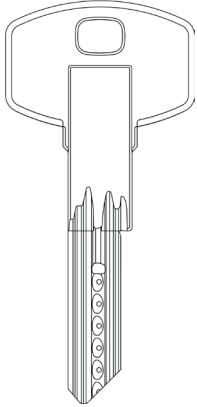

(RS Sirius Prf. 300-301 -6P)

System protected by a password issued by Silca on receipt of authorization.

Sistema protetto da password rilasciata da Silca a fronte di autorizzazione.

System geschützt durch von Silca geliefertes Passwort auf Genehmigung.

Système protégé par un password qui est émis par Silca sur autorisation.

Sistema protegido con contraseña que manda Silca previa autorización.

Sistema protegido por uma password emitida por Silca contra a autorização.



FUTURA PRO
≥ SW 3.45.0

OPTIONAL



D7A7781ZB

166 Jaw
Ganascia 166
166 Backe
Mâchoire 166
Quijada 166
Garra 166

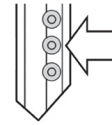

OPTIONAL



D7a7782ZB

167 Jaw
Ganascia 167
167 Backe
Mâchoire 167
Quijada 167
Garra 167

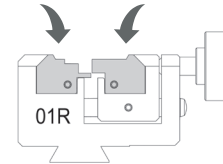
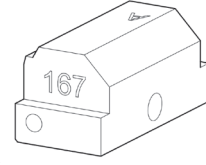
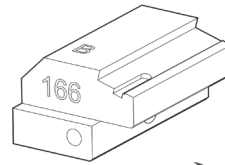

OPTIONAL



D744354ZB

Cutter 05D
Fresa 05D
Fräser 05D
Fraise 05D
Fresa 05D
Fresa 05D

NEW

OPTIONAL



D7A7790ZB



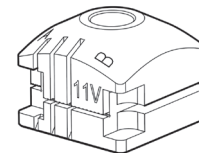

Clamp 11V
Morsetto 11V
11V Spannbacke
Etau 11V
Mordaza 11V
Mordente 11V

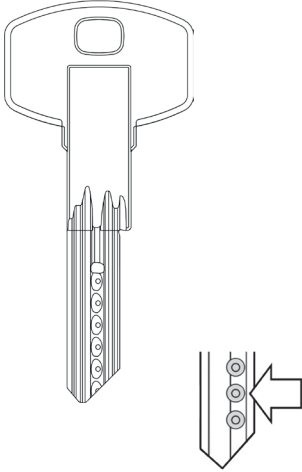

NEW

(*) This is a trademark of a third party not affiliated nor linked with Silca S.p.A. or the dormakaba Group. Silca S.p.A. and dormakaba Group do not own any intellectual property right nor have been granted any license with regard to such trademark, which is hereby used only to indicate the intended purpose of Silca's products.

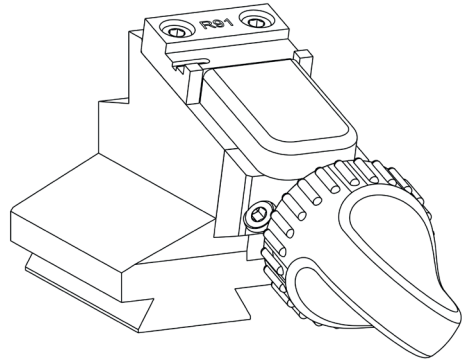
Silca key blanks are compatible with third party manufacturers' cylinders specified here below:

<p>DOM* (DE)</p>  <p>(RS Sirius Prf. 300-301 -6P)</p> <p><small>System protected by a password issued by Silca on receipt of authorization. Sistema protetto da password rilasciata da Silca a fronte di autorizzazione. System geschützt durch von Silca geliefertes Password auf Genehmigung. Système protégé par un password qui est émis par Silca sur autorisation. Sistema protegido con contraseña que manda Silca previa autorización. Sistema protegido por uma password emitida por Silca contra a autorização.</small></p>	 <p>TRIAX PRO ≥ SW 3.0.037 DB 60.00</p>  <p>TRIAX QUATTRO ≥ SW 1.4.072 DB 60.00</p>	<p>OPTIONAL</p> <div style="display: flex; justify-content: space-between;"> <div data-bbox="710 347 798 459"> <p>◆ CODE</p> <p>○ COPY</p> </div> <div data-bbox="1460 347 1532 414" style="border: 2px solid red; border-radius: 50%; padding: 5px; color: white; text-align: center; font-weight: bold;">NEW</div> </div> <div style="margin-top: 20px;"> <p>D7A8174ZB</p> <p>Clamp R91 Morsetto R91 R91 Spannbacke Etau R91 Mordaza R91 Mordente R91</p>  </div> <div style="margin-top: 40px;"> <p>OPTIONAL</p> <div style="display: flex; align-items: center;">  <div data-bbox="1061 907 1332 1108"> <p>D734579ZB</p> <p>Cutter W295 (carbide) Fresa W295 (metallo duro) Fräser W295 (Hartmetall) Fraise W295 (au carbure) Fresa W295 (metal duro) Fresa W295 (metal duro)</p> </div> </div> </div>
---	---	--

(*) This is a trademark of a third party not affiliated nor linked with Silca S.p.A. or the dormakaba Group. Silca S.p.A. and dormakaba Group do not own any intellectual property right nor have been granted any license with regard to such trademark, which is hereby used only to indicate the intended purpose of Silca's products.

> More info at mykeyspro.com

Silca key blanks are compatible with third party manufacturers' cylinders specified here below:

DOM* (DE)

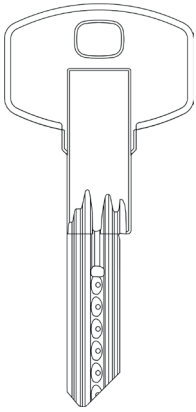

(RS Sirius Prf. 300-301 -6P)

System protected by a password issued by Silca on receipt of authorization.

Sistema protetto da password rilasciata da Silca a fronte di autorizzazione.

System geschützt durch von Silca geliefertes Passwort auf Genehmigung.

Système protégé par un password qui est émis par Silca sur autorisation.

Sistema protegido con contraseña que manda Silca previa autorización.

Sistema protegido por uma password emitida por Silca contra a autorização.



UNOCODE F800
UNOCODE F900

OPTIONAL



D7A7814ZB

Jaw set U29-L29

Set ganasce U29-L29

Satz Backen U29-L29

Ens.mâchoires U29-L29

Juego quijadas U29-L29

Conjunto de garras U29-L29

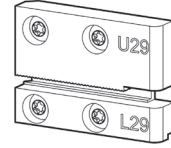

NEW



UNOCODE F100
UNOCODE F400
UNOCODE F600

OPTIONAL



D7A7814ZB

Jaw set U29-L29

Set ganasce U29-L29

Satz Backen U29-L29

Ens.mâchoires U29-L29

Juego quijadas U29-L29

Conjunto de garras U29-L29

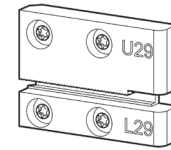

NEW

OPTIONAL



D7A3836ZB

V3 clamp

Morsetto V3

V3 Spannbacke

Étau V3

Mordaza V3

Mordente V3

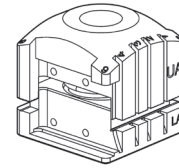

(*) This is a trademark of a third party not affiliated nor linked with Silca S.p.A. or the dormakaba Group. Silca S.p.A. and dormakaba Group do not own any intellectual property right nor have been granted any license with regard to such trademark, which is hereby used only to indicate the intended purpose of Silca's products.



LEGAL NOTES

In compliance with current regulations relating to industrial property, please note that - but for "Silca", "dormakaba", "Kaba", "Ilco" and "Advanced Diagnostics" - the trademarks or trade names mentioned in our document are the exclusive property of third parties not affiliated nor linked with Silca S.p.A. or the dormakaba Group. Silca S.p.A. and dormakaba Group do not own any intellectual property right nor have been granted any license with regard to such trademarks and trade names, which are hereby used only to indicate the intended purpose of Silca's products. / This catalogue is reserved exclusively for professional key cutters who use Silca products. The illustrations and technical data regarding the products in the document are to be considered indicative. Silca reserves the right to alter products designs, dimensions or info to improve the products quality. The contents of this document are fully protected by Copyright and may not be copied or reproduced in any form, without written permission from Silca S.p.A. For any dispute the competent Court is that of Treviso, the applicable law is that of Italy.

RECHTLICHE HINWEISE

In Übereinstimmung mit den geltenden Bestimmungen zum gewerblichen Eigentum weisen wir darauf hin, dass - mit Ausnahme von "Silca", "dormakaba", "Kaba", "Ilco" und "Advanced Diagnostics" - die in unserem Dokument erwähnten Markenzeichen oder Handelsnamen das ausschließliche Eigentum Dritter sind, die weder der Silca S.p.A. noch der dormakaba Gruppe angehören oder mit diesen verbunden sind. Diese Markenzeichen oder Handelsbezeichnungen werden hier nur erwähnt, um auf die bestimmungsgemäße Verwendung der Silca-Produkte hinzuweisen. / Dieser Katalog ist ausschließlich professionellen Schlüsseldiensten vorbehalten, die Silca-Produkte verwenden. Die in diesem Dokument enthaltenen Abbildungen und technischen Daten der Produkte sind als Richtwerte zu betrachten. Silca behält sich vor, etwaige Änderungen, die zur Verbesserung des Produktes beitragen, vorzunehmen. Alle Zeichnungen und Fotos sind Eigentum der Firma Silca. Jede Reproduktion, auch teilweise, ist ohne ausdrückliche Genehmigung der Silca S.p.A. gesetzlich untersagt. Für alle Streitigkeiten ist das Gericht von Treviso zuständig, das geltende Recht ist italienisch.

AVISOS LEGALES

En cumplimiento de la normativa vigente en materia de propiedad industrial, se recuerda que, salvo para "Silca", "dormakaba", "Kaba", "Ilco" y "Advanced Diagnostics", las marcas y los nombres comerciales citados en nuestro documento son propiedad exclusiva de terceras sociedades, no afiliadas ni asociadas con Silca S.p.A. o el Grupo dormakaba. Dichas marcas o denominaciones comerciales se citan aquí solamente para indicar el empleo de destino de los productos Silca. / Este catálogo queda reservado exclusivamente a los duplicadores profesionales, que utilizan los productos Silca. Las ilustraciones y los datos técnicos de los productos contenidos en el documento se han de considerar indicativos. Silca se reserva el derecho, quedando invariables las características principales de los productos, de modificar todo lo que considere necesario y oportuno para mejorar la calidad de sus artículos. Todos los dibujos y fotografías pertenecen a Silca; según determina la Ley, se prohíbe toda reproducción, total o parcial, sin autorización por escrito de Silca S.p.A. Para cualquier litigio el tribunal competente es el de Treviso, la ley vigente es la italiana.

NOTE LEGALI

In ottemperanza alla normativa vigente in materia di proprietà industriale, si ricorda che - fatta eccezione per "Silca", "dormakaba", "Kaba", "Ilco" e "Advanced Diagnostics" - i marchi o i nomi commerciali citati nel nostro documento sono di esclusiva proprietà di terzi, non affiliati né collegati a Silca S.p.A. o al Gruppo dormakaba. Silca S.p.A. e il Gruppo dormakaba non possiedono alcun diritto di proprietà intellettuale né agli stessi è stata concessa alcuna licenza in relazione a detti marchi o denominazioni commerciali, i quali sono qui citati solo per indicare la destinazione d'uso dei prodotti Silca. / Questo catalogo è riservato esclusivamente ai duplicatori professionisti che utilizzano i prodotti Silca. Le illustrazioni e i dati tecnici dei prodotti contenuti nel documento debbono considerarsi indicativi. Silca si riserva il diritto, ferme restando le caratteristiche essenziali dei prodotti, di apportare tutte le modifiche che ritiene necessarie e opportune al fine di migliorare la qualità dei prodotti. Tutti i disegni e le fotografie sono di proprietà di Silca, ogni riproduzione anche parziale, senza autorizzazione scritta di Silca S.p.A. è vietata secondo termini di legge. Per qualsiasi controversia il foro competente è quello di Treviso, la legge vigente è quella italiana.

MENTIONS LÉGALES

Conformément à la législation en vigueur en matière de propriété industrielle, il est rappelé que - à l'exception de "Silca", "dormakaba", "Kaba", "Ilco" et "Advanced Diagnostics" - les marques ou noms commerciaux mentionnés dans notre document sont la propriété exclusive de tiers, non affiliés, ni liés à Silca S.p.A. ou au Groupe dormakaba. Ces marques ou dénominations commerciales ne sont mentionnées ici que pour indiquer la destination des produits Silca. / Ce catalogue est exclusivement réservé aux reproducteurs professionnels qui utilisent les produits Silca. Les illustrations et les données techniques des produits contenues dans le document doivent être considérées comme indicatives. Bien que les caractéristiques essentielles des produits soient invariables, Silca se réserve le droit d'apporter toutes les modifications qu'elle retiendra nécessaires et opportunes afin d'améliorer la qualité de ses produits. Tous les dessins et photos sont propriété Silca et toute reproduction, même partielle, sans l'autorisation écrite préalable de Silca S.p.A. est interdite conformément aux prescriptions légales. Pour tout litige, le tribunal compétent est celui de Trévise, la loi en vigueur est italienne.

NOTÍCIAS LEGAIS

No respeito das normas em vigor relativas à propriedade industrial, lembra-se que - exceptuando "Silca", "dormakaba", "Kaba", "Ilco" e "Advanced Diagnostics" - as marcas ou os nomes comerciais citados no nosso documento são propriedade exclusiva de terceiros, não associados nem ligados à Silca S.p.A. ou ao Grupo dormakaba. Essas marcas ou denominações comerciais são citadas aqui somente para indicar o uso pretendido dos produtos Silca. / Este catálogo é reservado exclusivamente aos profissionais da duplicação que utilizam os produtos Silca. As figuras e as características técnicas dos produtos contidas no documento são facultadas a título indicativo. Mesmo que as características essenciais dos produtos sejam invariáveis, à Silca reserva-se o direito de modificar ser necessário e oportuno os produtos, afim de melhorar a sua qualidade. Todos os desenhos e fotos são propriedade da Silca, e é proibida a sua reprodução mesmo parcial sem a autorização escrita da Silca S.p.A. conforme as prescrições legais. Para qualquer litígio o tribunal competente é o de Treviso, a lei vigente é a italiana.